

# MOBI 15

Art.-Nr.

355 476  
355 477

580  
1702  
180  
mm

1/6  
VO

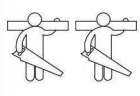

60 min



PZ2; PZ1

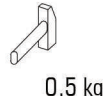

0,5 kg

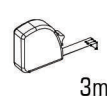

3m

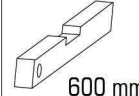

600 mm

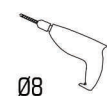

Ø8

ID	ID			
19844	②	1682*178*16	1x	1/1
19292	③	544*85*16	3x	1/1
19293	④	544*84*16	1x	1/1
19845	⑤	1682*178*16	1x	1/1
19295	⑥	580*180*16	1x	1/1
19296	⑦	538*307*16	5x	1/1
19297	⑧	530*70*10	5x	1/1
19298	⑨	530*140*10	5x	1/1

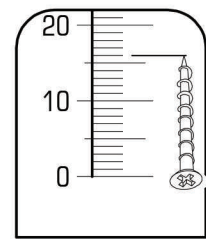
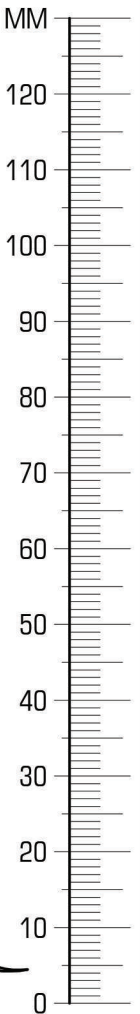
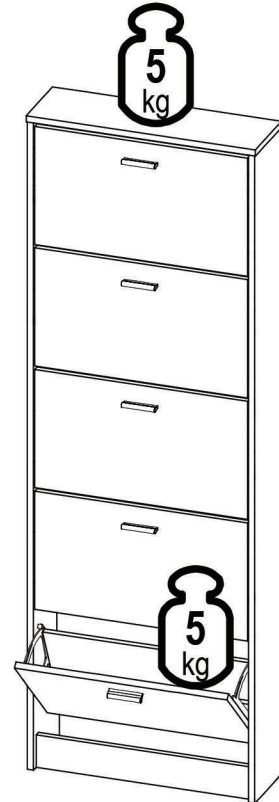
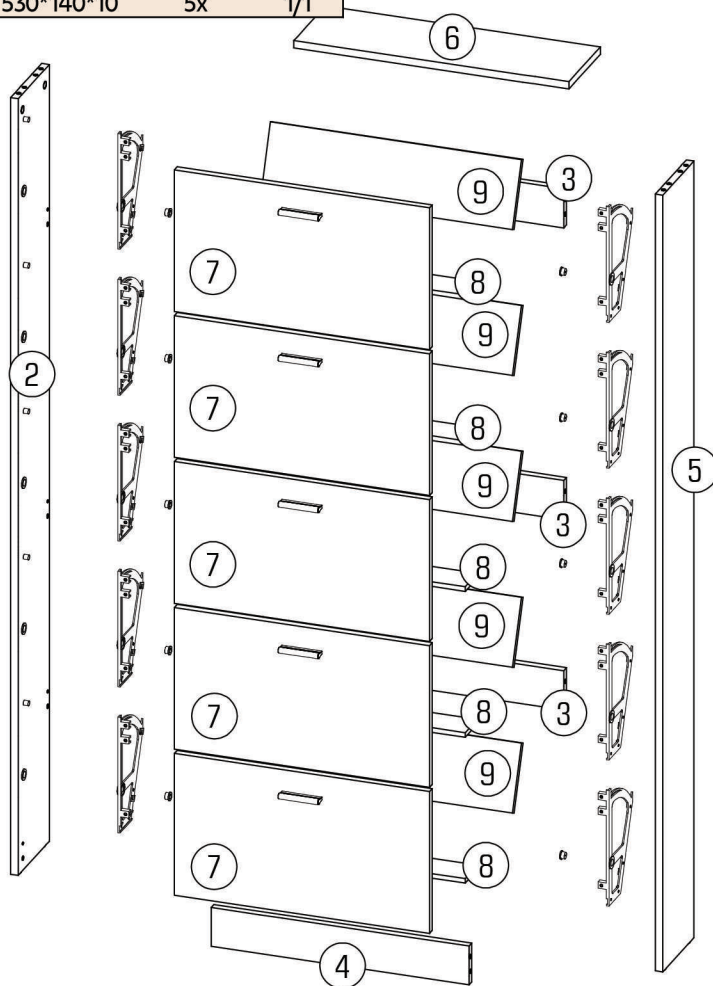
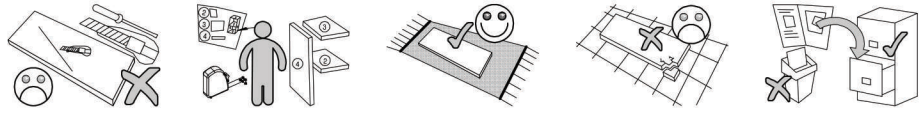

22244,01		Ø3,5x16	22236,00		Ø2,5x16	27000,00		Ø8x30	30091,00		70013,01		Ø15x13	70021,01		22255,00		Ø5,0x50	22430,00		Ø4x25	22708,00		Ø6,0x16
A	2x		B	40x		C	12x		D	4x	E	12x		F	12x	G	1x		H	10x		J	40x	
		24101,00		Ø10	31103,00		24113,00		24114,00		24115,00		32314,01		L=85	31131,00		31130,00						
K	4x		L	1x		M	1x		N	10x	P	10x		Q	10x	R	5x		S	5x		T	5x	

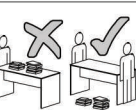
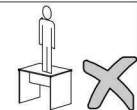
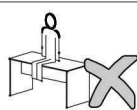
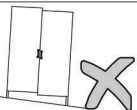

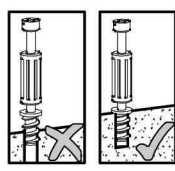
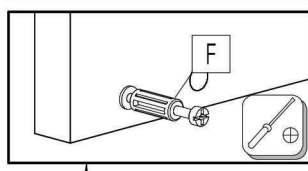
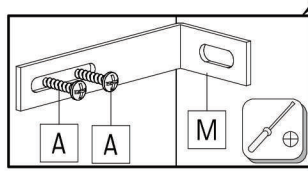
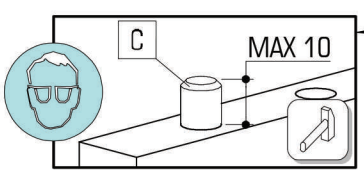
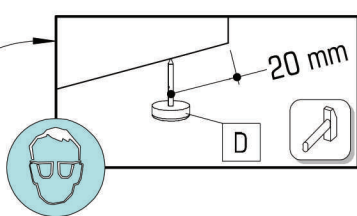
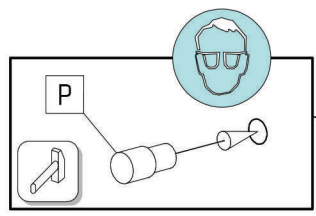
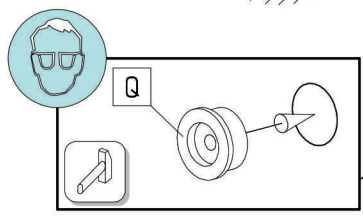
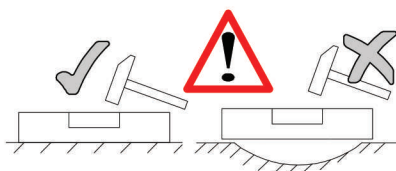
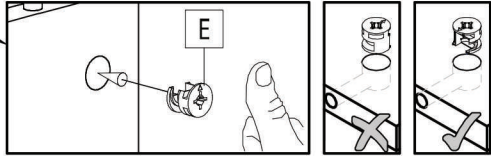
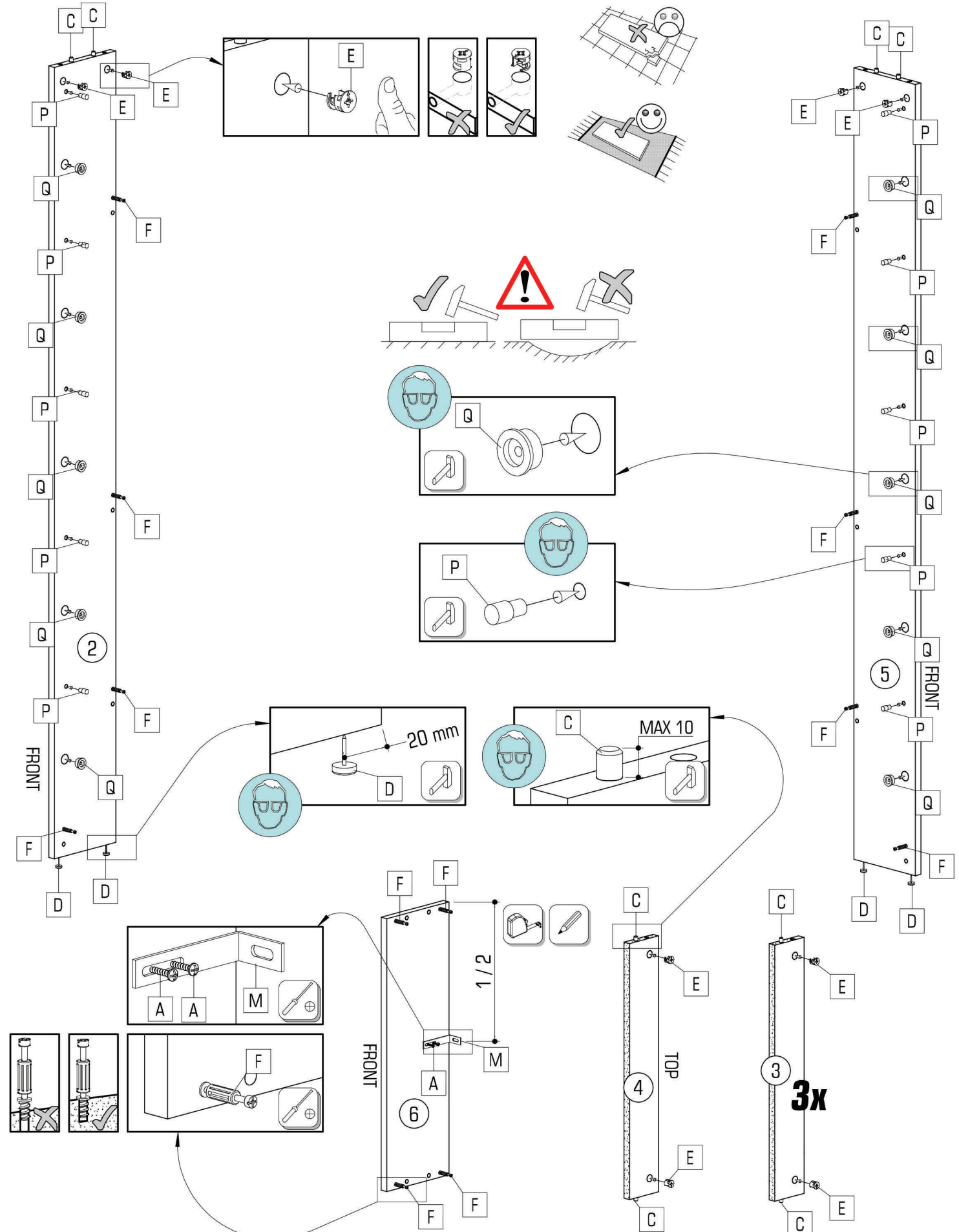

# 2/6 MOBI 15

A 2x	C 12x	D 4x	E 12x	F 12x	M 1x	P 10x	Q 10x

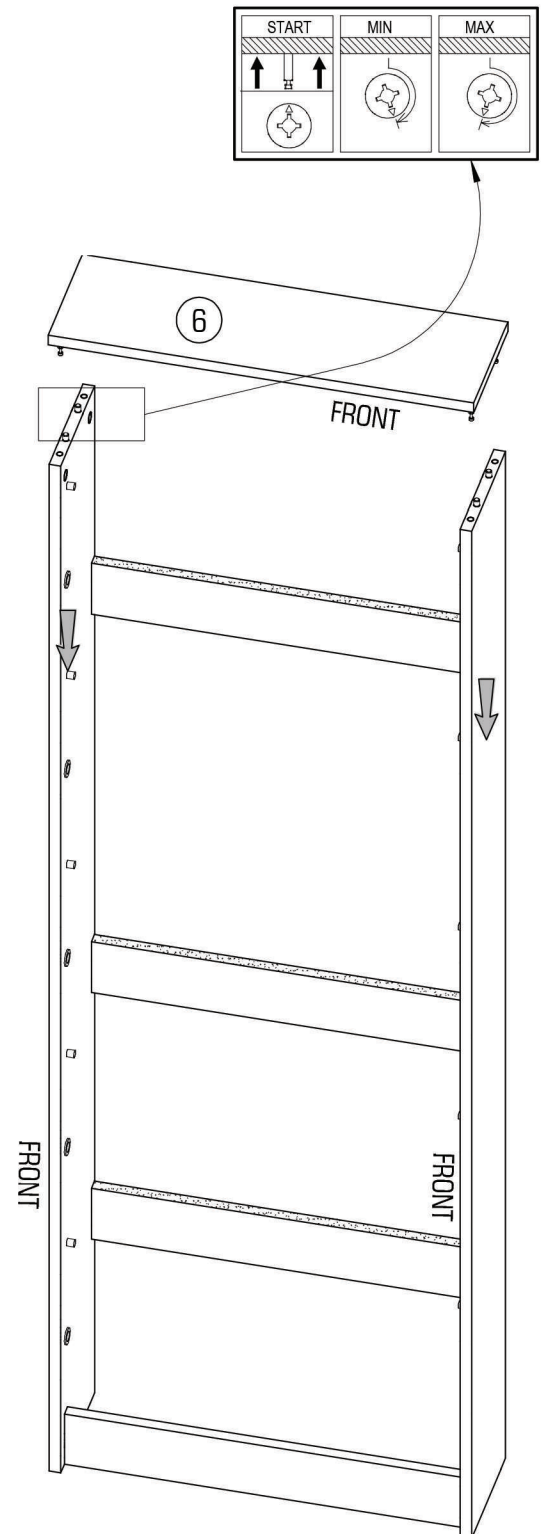
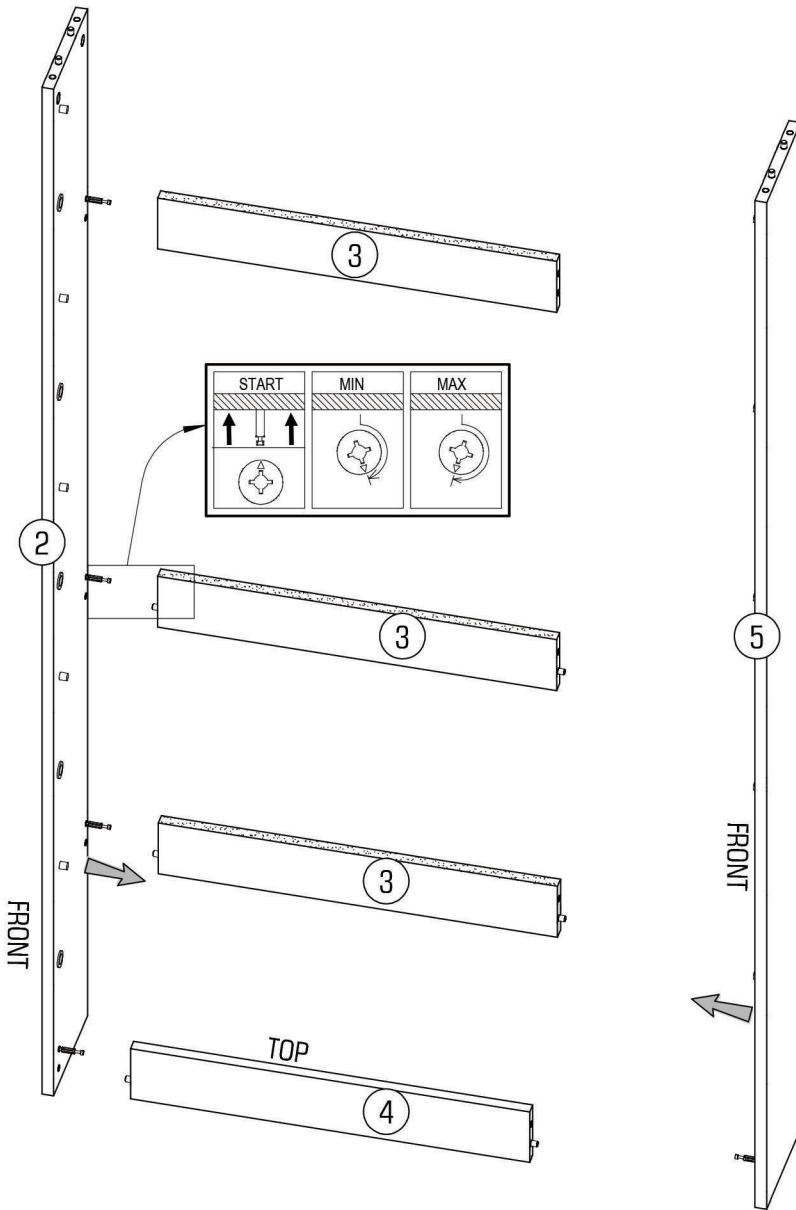
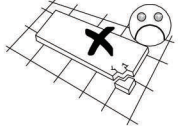
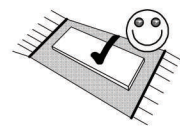

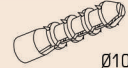

# 4/6 MOBI 15

		
Ø5,0x50		Ø10
G 1x	K 4x	L 1x

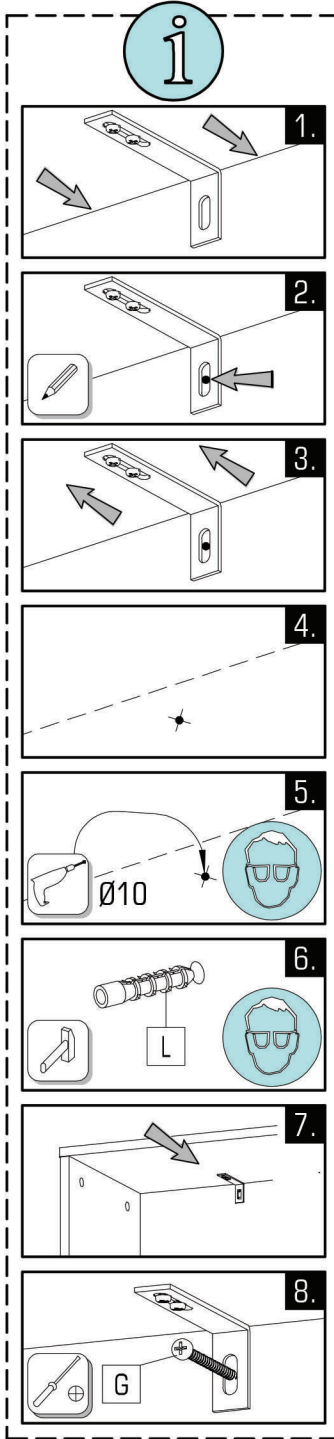
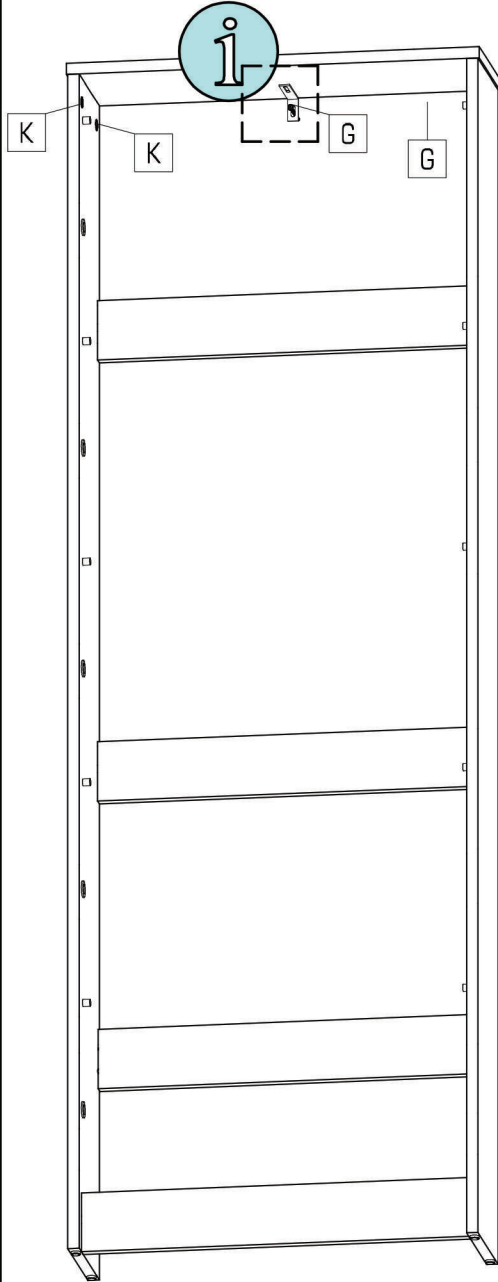
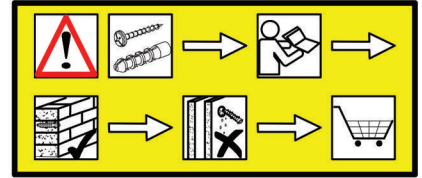
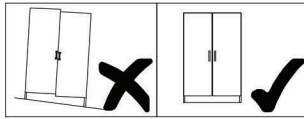

Caution! The wall must be examined before assembly. The included universal wall plugs are only suitable for using in firm masonry such as concrete block or brick. Do not use the wall plugs in masonry such as hollow brick, lightweight block, surfaces such as gypsum plasterboard or other framing systems. If applicable, particular wall plugs must be used! These are available at a specialised store (hardware store). In case of non-compliance, the manufacturer/retailer or importer do not assume liability.

Upozornenie! Pevnosť steny sa musí pred montážou bezpodmienečne skontrolovať. Priložené univerzálne hmoždenky používajte jedine pre pevné murivo ako je betón/tehla. Hmoždenky sa nesmú používať v prípade ľahkého stavebného muriva, dutá tehla, Sádrokartónová doska, alebo iných konštrukcií rámu. U týchto stien je nutné použiť špeciálne hmoždenky! Tieto je možné dostať v špeciálnych predajniach so stavebným materiálom. Pri nedodržaní pokynov nepreberajú výrobcovia/predajci a dodávateľa zodpovednosť za vzniknuté škody.

Upozornění! Před montáží je nutné zkontrolovat stav stěny. Přiložené univerzální hmoždinky jsou určeny pouze k použití pro pevné zdivo jako beton/cihly. Hmoždinky do zdi se nesmí používat u dutinová cihla, zdiva jako porovity stavební kámen, sádkartónová deska nebo jiný měkký materiál. U těchto zdív jsou nutné použít speciální hmoždinky! Jsou k dostání v speciálních prodejnách se stavebním materiálem. Při nedodržení těchto pokynů výrobce/prodeje a dovozce neručí za způsobené škody.

Pažnja! Prije montaže obvezno provjerite svojstvo zida. Priložene univerzalne tiplje namijenjene su isključivo za masivne zidove od betona/opeke. Tiplje za masivne zidove ne smiju se koristiti za zidove kao npr šupljina opeka laki sastavni elementi, gips-kartonske ploče ili drugi modularni načini gradnje. Za te zidove potrebne su eventualno specijalne tiplje! Iste su dostupne u specijaliziranim trgovinama građevinskim materijalom. U slučaju nepridržavanja prethodno navedenih napomena, proizvođač/trgovac i uvoznik ne preuzimaju odgovornost!

Achtung! Die Wandbeschaffenheit ist vor der Montage unbedingt zu prüfen. Die beigelegten Universaldübel sind ausschließlich nur zur Verwendung für festes Mauerwerk wie Beton/Ziegel. Die Mauerdübel dürfen nicht bei Mauerwerk wie Hohlraumziegel, Leichtbausteinen, Gipskartonplatte oder anderer Rahmenbauweise verwendet werden. Bei diesen Mauerwerken sind gegebenenfalls Spezialdübel zu verwenden! Diese sind in einem Fachgeschäft erhältlich. Bei Nichteinhaltung wird seitens Produzenten/Händler und Importeur keine Haftung übernommen.

Vigyázat! Szerelés előtt a falfelületet feltétlenül vizsgálja meg. A mellékelt univerzális tiplje kizárólag stabil falazathoz használható mint például beton/tegla. A fal tiplje nem használható könnyű építőkövekhez, üreg tégla, gipszkarton lapokhoz vagy más fávázás építményekhez. Ezekhez a falfelületekhez csak speciális tiplik használhatóak, melyek szaküzletekben (barkácsruházakban) beszerezhetőek. Fentiek figyelmen kívül hagyása esetén a gyártó/kereskedő vagy forgalmazó nem vállal felelősséget.

Uwaga! Ścianę należy sprawdzić przed montażem. Dołączone uniwersalne kołki rozporowe są odpowiednie tylko do stosowania w mocnych murach, takich jak beton lub cegła. Nie rób za pomocą kołków rozporowych murowanych, takich jak pustak, lekka kostka, powierchnie takie jak płyty gipsowo-kartonowe lub inne systemy ram. Jeśli dotyczy, muszą to być określone kołki rozporowe być użytych! Są one dostępne w specjalistycznym sklepie niezgodność, producent / sprzedawca lub importer nie ponoszą odpowiedzialności.

Prudență! Zidul trebuie examinat înainte de asamblare. Prizele de perete sunt adecvate numai pentru utilizarea în zidărie fermă, cum ar fi betonul bloc sau cărămidă. Nu folosiți zidăria zidurilor de perete, cum ar fi cărămida goală, blocul ușor, suprafețe cum ar fi gips-carton sau alii încadrare sisteme. Dacă este cazul, trebuie folosite anumite prize de perete! Acestea sunt disponibile la un magazin specializat (magazin de hardware). În caz de nerespectare, producătorul / vânzătorul cu amănuntul sau importatorul nu își asumă răspunderea.

Pozor! Pred montážo preverite stanje stene. Priloženi univerzalni mozniki so izključno samo za uporabo na čvrstem zidovju, kot sta beton in opeka. Stenski mozniki se ne smejo uporabljati pri zidovju kot so votlino opeke, zidaki za lahko gradnjo, mavčne plošče ali druge okvirne gradnje. Pri teh zidovjih morate v danih primerih uporabljati posebne moznike. Ti so na voljo v specializiranih trgovinah (trgovinah z gradbenim materialom). Pri upoštevanju se s strani proizvajalca/trgovca in uvoznika ne prevzame jamstvo.

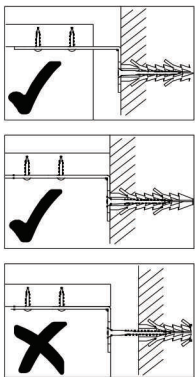

EN WARNING  
SK VÝSTRAHA  
CZ VAROVÁNÍ  
HR UPOZORENJE  
DE WARNUNG  
HU FIGYELEM  
SE VARNING  
SI OPOZORILO  
PL OSTRZEŻENIE

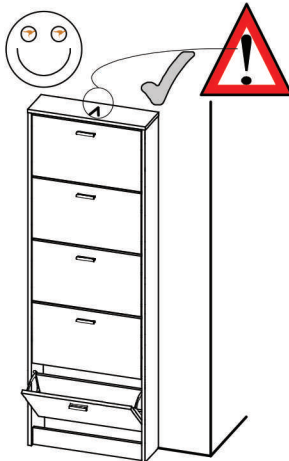

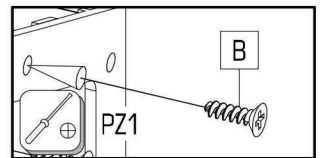
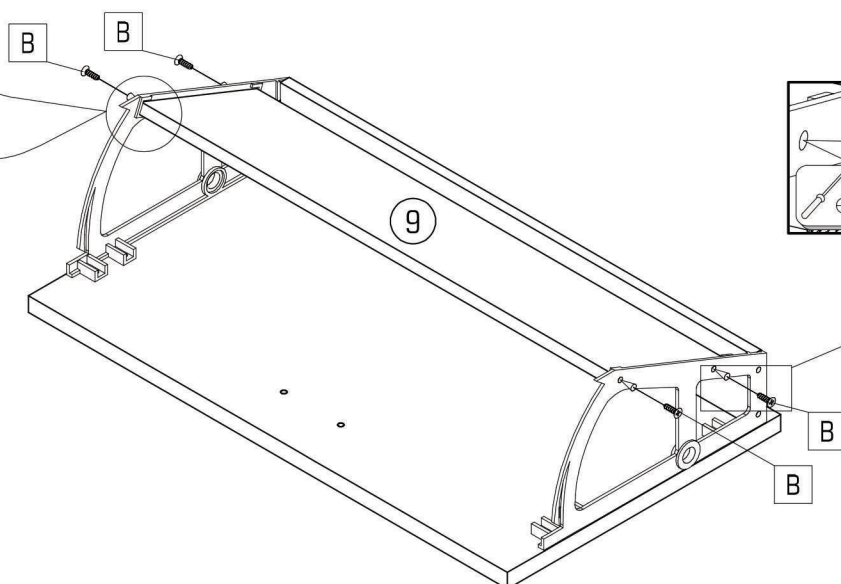
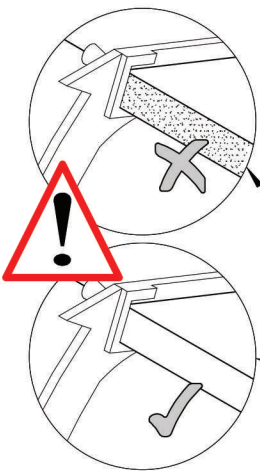
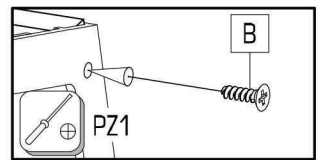
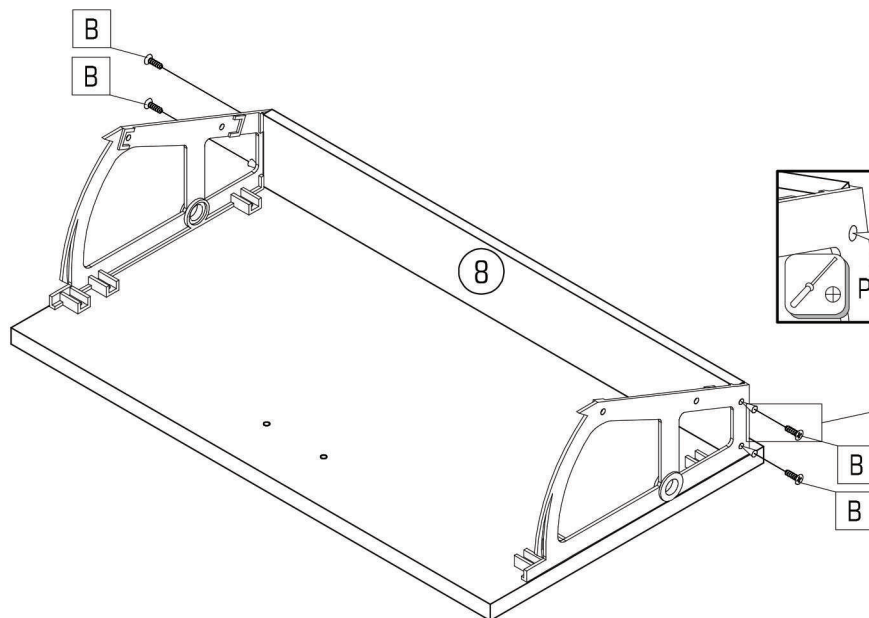
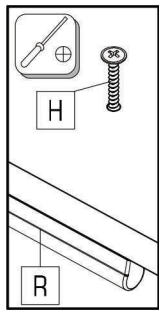
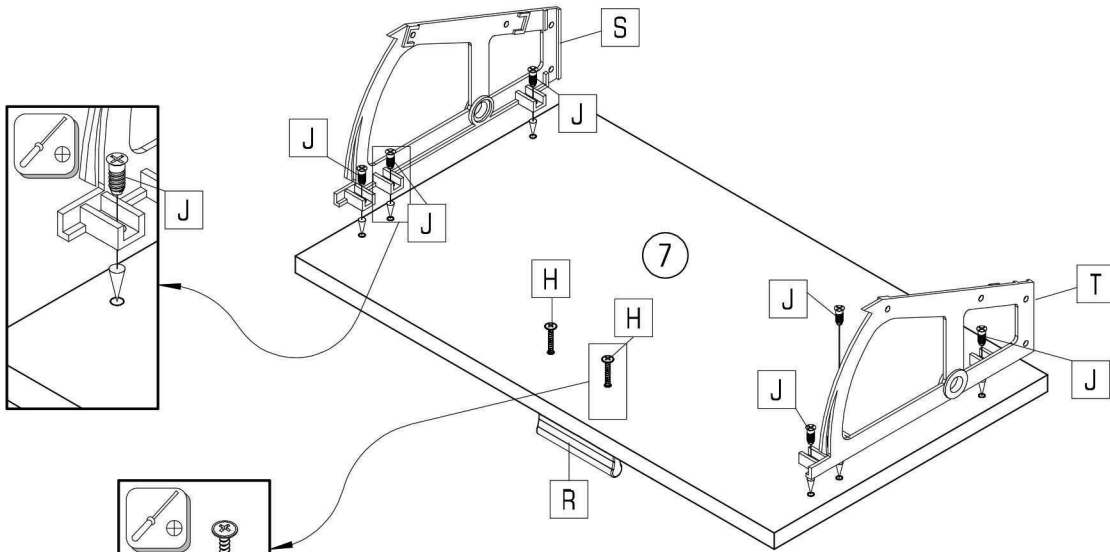
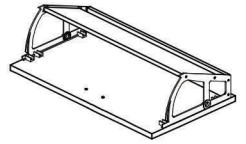

B 40x	H 10x	J 30x	R 5x	S 5x	T 5x

5x



# 6/6 MOBI 15

	$\varnothing 6,0 \times 16$		
J	10x	N	10x

